

U.32T2-8 U.32T - Lockable 2-leg sliding-leg pullers

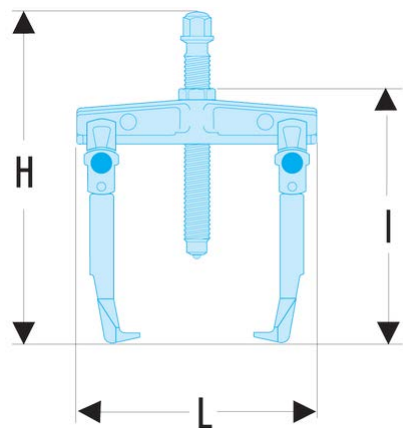

Description:

- Versatile: conversion possible in inside or outside grip with the same meg.
- Safety: knurled locking button.

A mini - maxi [mm]:	20 - 80
A1 mini - maxi [mm]:	90 - 140
B mini - maxi [mm]:	90 - 140
L x l x H [mm]:	142 x 150 x 170
P maxi [mm]:	105
Hex Size [mm]:	13
Puller:	21
Ton [t]:	2
Screw Size:	U.32T2-1
Screw Size [mm]:	13
T [kN]:	20
[kg]:	1,100