

## R.4EL | R.EL - 1/4" long-reach metric 12-point sockets





### Standards:

NF ISO 2725-1, NF ISO 1711-1,  
ISO 2725-1, ISO 1711-1, DIN  
3124, ASME B107.5

### Description:

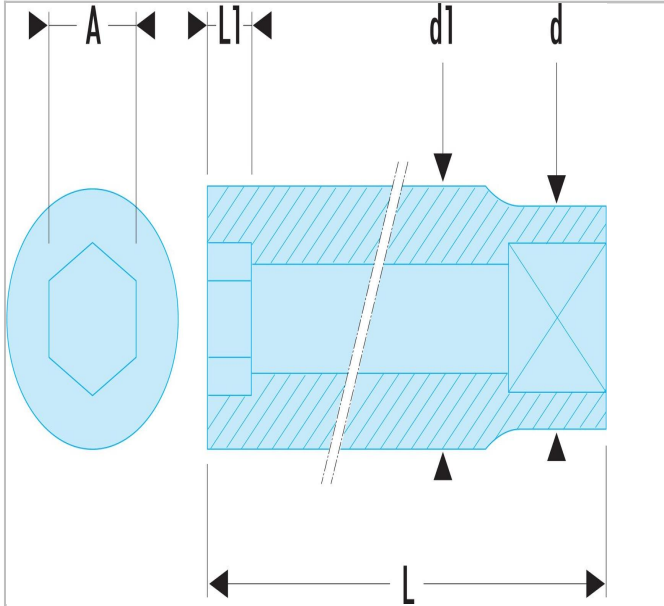
- OGV® profile: more powerful tightening, preserves fasteners.
- Long-reach sockets for long recess or thread access.
- Available as rack sets (Ref REL.40U).
- Finish: bright chrome.



 R.4EL	
A [mm]	0.2
Diameter [mm]	6.7
Diameter D1 [mm]	11.2
Length L [mm]	50.0
Length L1 [mm]	4.0
Weight [Kg]	0.018
12-Point [mm]	12.0