

NP.200B NP.B - Sets with torque multiplier

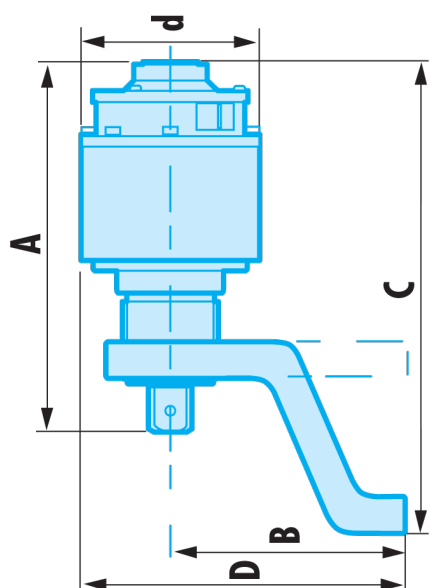

Description:

- Powerful tightening and untightening without external energy source.
- Constant multiplication ratio: 25:1.
- Safety: input torquer limiter.
- Non-return system.
- Rate = 25:1.
- Supplied with 2 reaction arms (straight and angled) and one spare drive square, with a compliance certificate.

A [mm]: 174

B [mm]: 165

C [mm]: 218

d [mm]: 72

Offset Arm: NP.250JC

Straight Arm: NP.250JD

Capacity Maxi [N.m]: 2000

F Square: 1

Male Square: 1/2

[kg]: 3,00