

E117392 | EXPERT 6 x 6 point flare nut wrenches

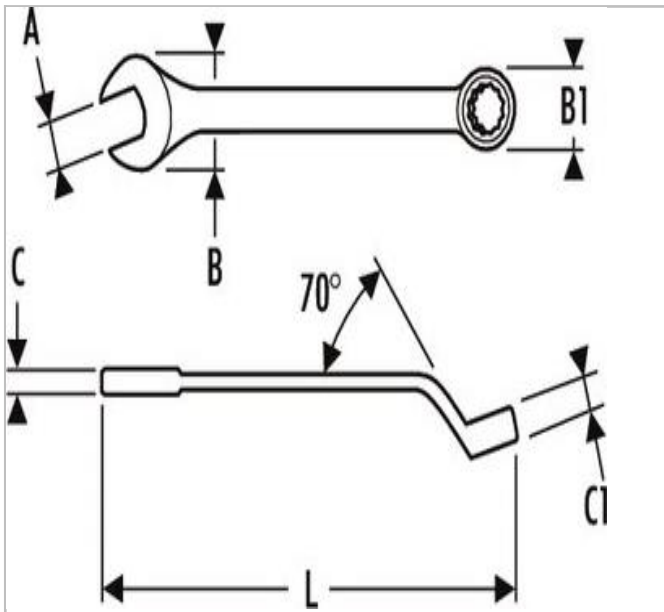

Description:

- DIN 3118
- ISO 691
- 12-point OGV® ring angled at 15°.
- Open end angled at 15° from handle axis.
- 6-point heads up to 12 x 14 mm.
- Forged in Chrome Vanadium steel.
- High chrome finish.



	E117392
A [in]	12
Length L [mm]	174.0
Head Height C [mm]	8.5
Head Height C1 [mm]	10.5
Head Width B [mm]	22.8
Head Width B1 [mm]	25.3
Weight [mm]	0.077
Diameter [mm]	9.0
Diameter D1 [mm]	11.0