

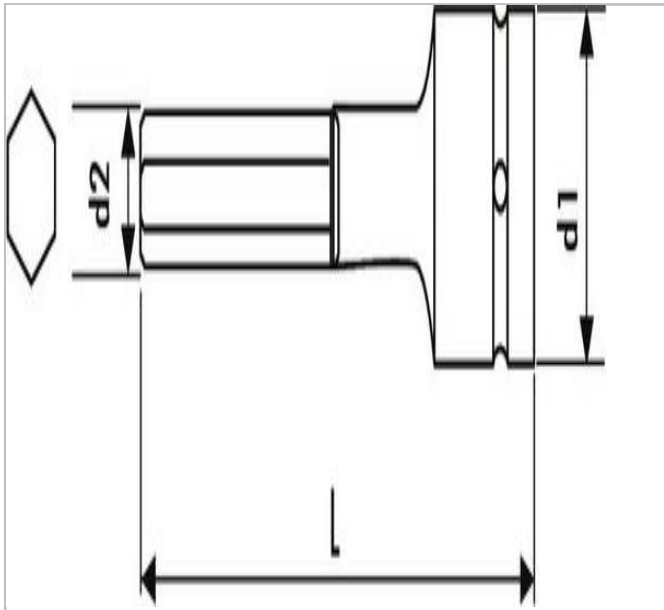

E113628 | EXPERT 1/2" Impact screwdriver hex bit



Description:

- Designed specifically to withstand demands of impact machinery.
- Chrome-Molybdenum steel.
- One piece screwdriver sockets.
- For your safety, use impact bit sockets with the appropriate rings and pins.



	E113628
A [mm]	14.0
Diameter D1 [mm]	25.0
Length L [mm]	75.0
Weight [g]	143.0
Hex Size [mm]	14.0
Diameter D2 [mm]	16.0