

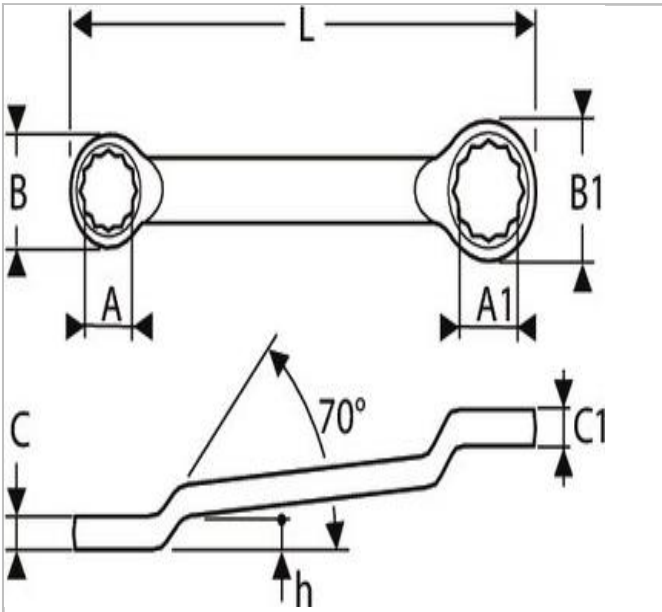

E113368 | EXPERT Offset ring wrenches - Metric



Description:

- ISO 691
- ISO 1711-1
- ISO 3318
- ISO 10104
- DIN 838
- 12-point OGV® ring wrenches offset by 70° for better access to recessed nuts.
- OGV® Ring profile maximizing contact surface with the nut for a longer lifetime.
- Forged in Chrome Vanadium steel.
- High chrome finish.



	E113368
A [mm]	27
Length L [mm]	372.0
Height H [mm]	37.0
Head Width B [mm]	42.0
Head Width B1 [mm]	45.2
Head Height C [mm]	15.0
Head Height C1 [mm]	16.0
Weight [Kg]	0.662