

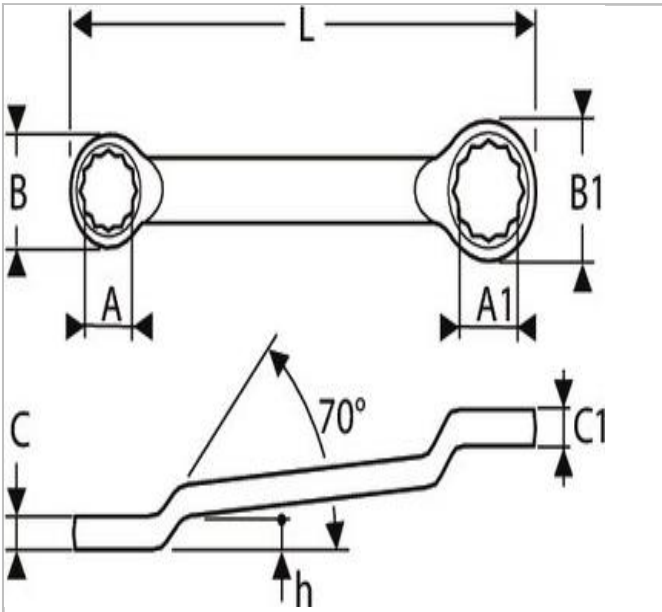

## E113364 | EXPERT Offset ring wrenches - Metric



### Description:

- ISO 691
- ISO 1711-1
- ISO 3318
- ISO 10104
- DIN 838
- 12-point OGV® ring wrenches offset by 70° for better access to recessed nuts.
- OGV® Ring profile maximizing contact surface with the nut for a longer lifetime.
- Forged in Chrome Vanadium steel.
- High chrome finish.



	E113364
A [mm]	13
Length L [mm]	245.0
Height H [mm]	26.8
Head Width B [mm]	19.0
Head Width B1 [mm]	25.2
Head Height C [mm]	9.0
Head Height C1 [mm]	11.0
Weight [Kg]	0.17