

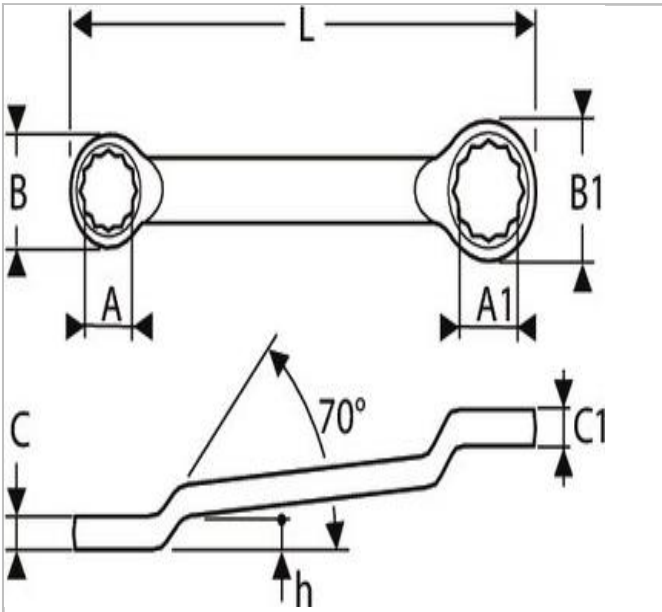

E113326 | EXPERT Offset ring wrenches - Metric



Description:

- ISO 691
- ISO 1711-1
- ISO 3318
- ISO 10104
- DIN 838
- 12-point OGV® ring wrenches offset by 70° for better access to recessed nuts.
- OGV® Ring profile maximizing contact surface with the nut for a longer lifetime.
- Forged in Chrome Vanadium steel.
- High chrome finish.



	E113326
A [mm]	16
Length L [mm]	246.0
Height H [mm]	28.5
Head Width B [mm]	24.2
Head Width B1 [mm]	25.7
Head Height C [mm]	10.4
Head Height C1 [mm]	10.9
Weight [Kg]	0.193