

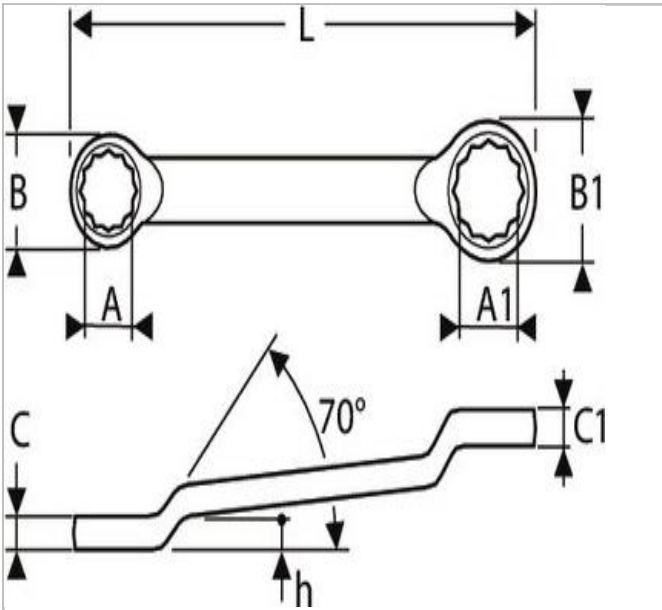

E113323 | EXPERT Offset ring wrenches - Metric



Description:

- ISO 691
- ISO 1711-1
- ISO 3318
- ISO 10104
- DIN 838
- 12-point OGV® ring wrenches offset by 70° for better access to recessed nuts.
- OGV® Ring profile maximizing contact surface with the nut for a longer lifetime.
- Forged in Chrome Vanadium steel.
- High chrome finish.



	E113323
A [mm]	10
Length L [mm]	206.0
Height H [mm]	22.5
Head Width B [mm]	16.0
Head Width B1 [mm]	17.8
Head Height C [mm]	7.4
Head Height C1 [mm]	7.9
Weight [Kg]	0.09