

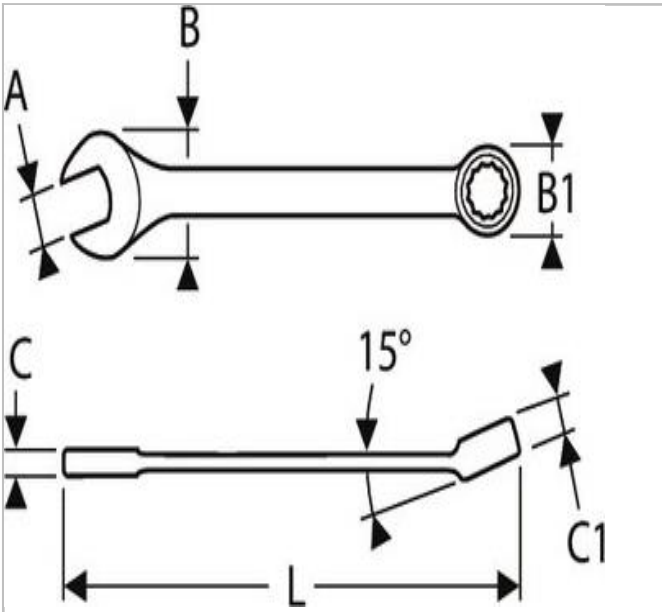

E113319 | EXPERT Combination wrenches - Inch



Description:

- ASME B 107-100
- 12-point OGV® ring angled at 15°.
- Open end angled at 15° from handle axis.
- OGV® profile maximizing the contact surface with the nut for a longer lifetime.
- Forged in Chrome Vanadium steel.
- High chrome finish.



	E113319
A [in]	11/16"
Length L [mm]	210.0
Thickness E1 [mm]	6.3
Thickness E2 [mm]	9.5
Head Width B [mm]	38.5
Head Width B1 [mm]	26.2
Weight [Kg]	0.21
Head Height C [mm]	6,3
Head Height C1 [mm]	9.5