

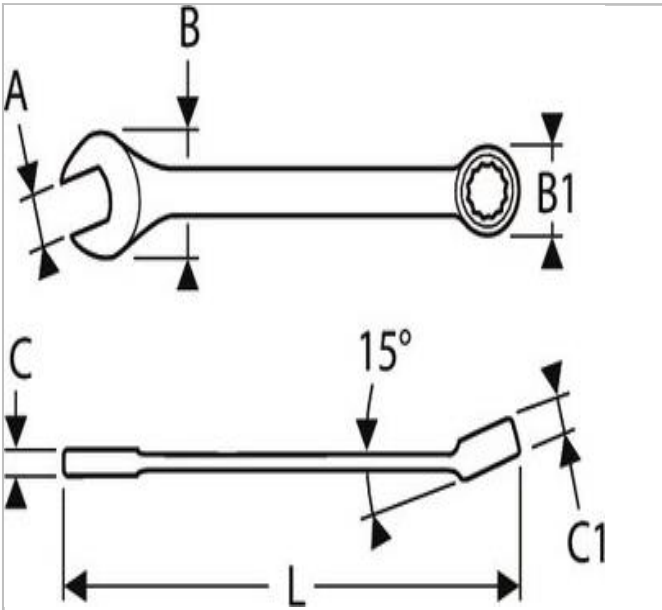

E113318 | EXPERT Combination wrenches - Inch



Description:

- ASME B 107-100
- 12-point OGV® ring angled at 15°.
- Open end angled at 15° from handle axis.
- OGV® profile maximizing the contact surface with the nut for a longer lifetime.
- Forged in Chrome Vanadium steel.
- High chrome finish.



	E113318
A [in]	5/8"
Length L [mm]	200.0
Thickness E1 [mm]	5.8
Thickness E2 [mm]	9.0
Head Width B [mm]	36.0
Head Width B1 [mm]	24.8
Weight [Kg]	0.11
Head Height C [mm]	5,8
Head Height C1 [mm]	9.0