

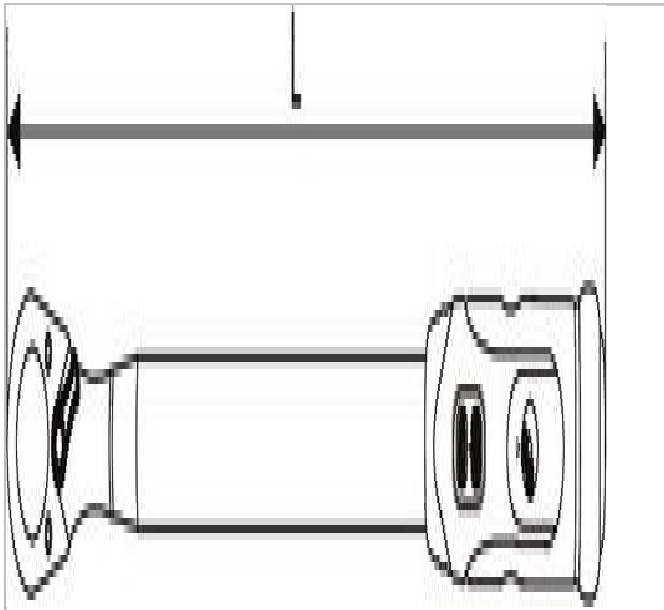

## E100106 | EXPERT Torque wrenches



### Description:

- ISO 6789
- Accuracy: +/4%.
- Comfortable grip.
- Direct torque value reading.
- Fast and easy setting.
- Supplied with calibration certificate.



	<b>E100106</b>
Length L [mm]	400.0
Weight [g]	988.0
Torque [Nm]	10 - 50
No. []	3/8