

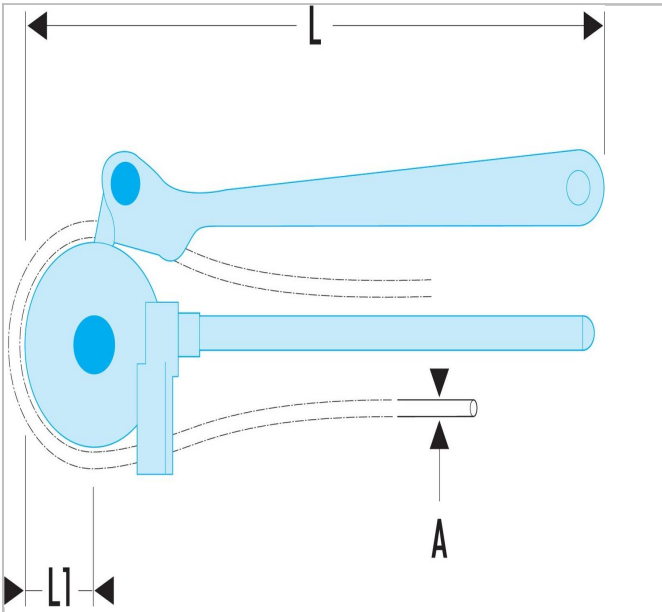

344B.8 | 344B - Bending pliers



Description:

- Capacity: 8 to 18 mm.
- To shape pipes in cold drawn or annealed copper.
- Easy use on the work place without particular installation.
- Bending angle measurement (0° - 180°).
- Can be carried on a tool box.
- Made in forged and machined steel.



	344B.8
A [mm]	8.0
Length L1 [mm]	14.0
Weight [Kg]	0.34