

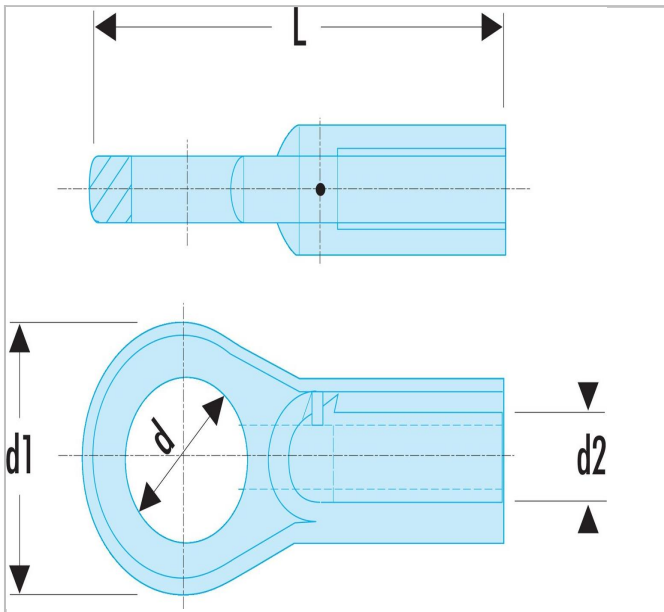

289.M8 | 289.M - Nut splitter



Description:

- For splitting a worn or jammed nut without damaging the screw thread.



	289.M8
Diameter [mm]	19.0
Diameter D Mini - Maxi [mm]	12 - 16
Diameter D1 [mm]	29.0
Diameter D2 [mm]	9.5
Length L [mm]	100.0
Weight [g]	170.0